

## Trademarks

OTOFIX is a trademark of Autel Intelligent Technology Corp., Ltd., registered in China, the United States, and other countries. All other marks are trademarks or registered trademarks of their respective holders.

## Copyright Information

No part of this manual may be reproduced, stored in a retrieval system or transmitted, in any form or by any means, electronic, mechanical, photocopying, recording, or otherwise without the prior written permission of Autel Intelligent Technology Corp., Ltd.

## Disclaimer of Warranties and Limitation of Liabilities

All information, specifications and illustrations in this manual are based on the latest information available at the time of printing.

Autel Intelligent Technology Corp., Ltd. reserves the right to make changes at any time without notice. While information of this manual has been carefully checked for accuracy, no guarantee is given for the completeness and correctness of the contents, including but not limited to the product specifications, functions, and illustrations.

Autel Intelligent Technology Corp., Ltd. will not be liable for any direct, special, incidental, indirect damages or any economic consequential damages (including the loss of profits).

---

### IMPORTANT

Before operating or maintaining this unit, please read this manual carefully, paying extra attention to the safety warnings and precautions.

---

## For Services and Support



[www.otofixtech.com](http://www.otofixtech.com)



(833) 686-1349 (OTO-1FIX) (North America)  
0086-755-86147779 (China)



[support@otofixtech.com](mailto:support@otofixtech.com)

For technical assistance in all other markets, please contact your local selling agent.

## Safety Information

---

For your own safety and the safety of others, and to prevent damage to the device and vehicles upon which it is used, it is important that the safety instructions presented throughout this manual be read and understood by all persons operating or coming into contact with the device.

There are various procedures, techniques, tools, and parts for servicing vehicles, as well as in the skill of the person doing the work. Because of the vast number of test applications and variations in the products that can be tested with this equipment, we cannot possibly anticipate or provide advice or safety messages to cover every circumstance. It is the automotive technician's responsibility to be knowledgeable of the system being tested. It is crucial to use proper service methods and test procedures. It is essential to perform tests in an appropriate and acceptable manner that does not endanger your safety, the safety of others in the work area, the device being used, or the vehicle being tested.

Before using the device, always refer to and follow the safety messages and applicable test procedures provided by the manufacturer of the vehicle or equipment being tested. Use the device only as described in this manual. Read, understand, and follow all safety messages and instructions in this manual.

## Safety Messages

---

Safety messages are provided to help prevent personal injury and equipment damage. All safety messages are introduced by a signal word indicating the hazard level.

---

### **DANGER**

Indicates an imminently hazardous situation which, if not avoided, will result in death or serious injury to the operator or to bystanders.

---

### **WARNING**

Indicates a potentially hazardous situation which, if not avoided, could result in death or serious injury to the operator or to bystanders.

---

## Safety Instructions

---

The safety messages herein cover situations Autel Intelligent Technology Corp., Ltd. is aware of. Autel Intelligent Technology Corp., Ltd. cannot know, evaluate or advise you as to all of the possible hazards. You must be certain that any condition or service procedure encountered does not jeopardize your personal safety.

---

 **DANGER**

When an engine is operating, keep the service area **WELL VENTILATED** or attach a building exhaust removal system to the engine exhaust system. Engines produce carbon monoxide, an odorless, poisonous gas that causes slower reaction time and can lead to serious personal injury or loss of life.

---

 **SAFETY WARNINGS**

- Wear safety glasses and protective clothing.
- NEVER smoke or allow a spark or flame in the vicinity of battery or engine.
- Have plenty of fresh water and soap nearby in case battery acid contacts skin, clothing or eyes.
- If battery acid contacts skin or clothing, wash immediately with soap and water. If acid enters eye, immediately flush eye with running cold water for at least ten minutes and get medical attention immediately.
- Use caution when working with metallic tools to prevent sparks or short circuits.
- Remove any jewelry or watches before you start servicing the battery.
- Keep hair, hands, and clothing as well as tester leads and cords away from moving blades and belts.

# CONTENTS

SAFETY INFORMATION .....	ii
SAFETY MESSAGES .....	ii
SAFETY INSTRUCTIONS .....	ii
<b>1 USING THIS MANUAL .....</b>	<b>1</b>
1.1 CONVENTIONS .....	1
<b>2 GENERAL INTRODUCTION .....</b>	<b>3</b>
2.1 OTOFIX BT1 BATTERY TESTER .....	4
2.1.1 Function Description .....	4
2.1.2 Power Sources.....	5
2.1.3 Technical Specifications .....	6
2.2 OTOFIX V1 — VEHICLE COMMUNICATION INTERFACE (VCI) .....	6
2.2.1 Function Description .....	7
2.2.2 Power Sources.....	8
2.2.3 Technical Specifications .....	8
2.3 OTHER ACCESSORIES.....	9
<b>3 GETTING STARTED .....</b>	<b>10</b>
3.1 POWER UP .....	10
3.1.1 Page Indicator and System Status Bar .....	11
3.1.2 Application Buttons .....	11
3.1.3 Drop-down Menu .....	13
3.2 POWER OFF.....	14
3.3 TEST PREPARATION.....	14
3.3.1 Inspecting the Battery .....	14
3.3.2 Connecting to a Battery .....	14
<b>4 IN-VEHICLE TEST.....</b>	<b>16</b>
4.1 START THE TEST .....	16
4.1.1 VCI Connection.....	17
4.2 BATTERY TEST.....	20
4.3 STARTER TEST.....	22
4.4 GENERATOR TEST .....	23
<b>5 OUT-VEHICLE TEST.....</b>	<b>25</b>

5.1 TEST PROCEDURE .....	25
5.2 TEST RESULTS.....	26
<b>6 BATTERY REPLACE .....</b>	<b>27</b>
<b>7 BATTERY RESET .....</b>	<b>29</b>
7.1 AUTO REGISTRATION (AFTER BATTERY REPLACEMENT) .....	29
7.1.1 BMS Reset.....	29
7.1.2 Electric Appliance Reset.....	30
7.2 SPECIAL FUNCTION.....	31
7.3 BATTERY USAGE HISTORY (ONLY FOR BMW VEHICLES) .....	32
<b>8 DIAGNOSTICS (SUBSCRIPTION ONLY) .....</b>	<b>33</b>
8.1 AUTO SCAN .....	34
8.2 CONTROL UNITS.....	35
8.2.1 ECU Information .....	36
8.2.2 Read Codes.....	37
8.2.3 Erase Codes .....	38
<b>9 MULTIMETER.....</b>	<b>40</b>
9.1 SAFETY INFORMATION.....	40
9.2 GETTING STARTED .....	41
9.3 SCREEN LAYOUT AND OPERATION.....	42
9.3.1 Multimeter Icon .....	43
9.3.2 Digital Display .....	43
9.3.3 Main View Section .....	43
9.3.4 Measurement Type Selection .....	44
<b>10 UPDATE .....</b>	<b>46</b>
<b>11 SETTINGS.....</b>	<b>48</b>
<b>12 DATA MANAGER .....</b>	<b>49</b>
12.1 TEST RECORDS .....	49
12.2 WORKSHOP INFORMATION .....	50
12.3 IMAGE.....	50
12.4 PDF.....	50
12.5 UNINSTALL APPS .....	50
12.6 DATA LOGGING.....	50

<b>13</b>	<b>REMOTE DESKTOP</b> .....	52
<b>14</b>	<b>REGISTER TOOL</b> .....	54
	14.1 REGISTRATION VIA TESTER .....	54
	14.2 REGISTRATION VIA AN INTERNET BROWSER ON A COMPUTER OR MOBILE DEVICE .....	54
<b>15</b>	<b>MAINTENANCE AND SERVICE</b> .....	55
	15.1 MAINTENANCE INSTRUCTIONS .....	55
	15.2 TROUBLESHOOTING CHECKLIST.....	56
	15.3 ABOUT BATTERY USAGE.....	56
	15.4 SERVICE PROCEDURES .....	57
	15.4.1 <i>Technical Support</i> .....	57
	15.4.2 <i>Repair Service</i> .....	58
<b>16</b>	<b>COMPLIANCE INFORMATION</b> .....	59
<b>17</b>	<b>WARRANTY</b> .....	61
	17.1 LIMITED ONE YEAR WARRANTY .....	61

# 1 Using This Manual

This manual contains device usage instructions.

Some illustrations shown in this manual may contain modules and optional equipment that are not included in your system. Contact your sales representative for availability of other modules and optional tools or accessories.

## 1.1 Conventions

The following conventions are used.

### **Bold Text**

Bold text is used to highlight selectable items such as buttons and menu options.

Example:

- Tap **OK**.

### **Notes and Important Messages**

*Notes*

A **NOTE** provides helpful information such as additional explanations, tips, and comments.

Example:

---

 **NOTE**

New Batteries reach full capacity after approximately 3 to 5 charging and discharging cycles.

---

## *Important*

**IMPORTANT** indicates a situation which, if not avoided, may result in damage to the test equipment or vehicle.

Example:

---

### **!** **IMPORTANT**

Keep the cable away from heat, oil, sharp edges and moving parts. Replace damaged cables immediately.

---

## **Hyperlink**

Hyperlinks, or links, that take you to other related articles, procedures, and illustrations are available in electronic documents. Blue italic text indicates a selectable hyperlink and blue underlined text indicates a website link or an email address link.

## **Illustrations**

Illustrations used in this manual are samples, the actual testing screen may vary for each vehicle being tested. Observe the menu titles and the on-screen instructions to make correct option selection.

## **Procedures**

An arrow icon indicates a procedure.

Example:

### ➤ **To use the camera:**

1. Tap the **Camera** button. The camera screen opens.
2. Focus the image to be captured in the view finder.
3. Tap the camera icon on the right side of the screen. The view finder now shows the captured picture and auto-saves the taken photo.
4. Tap the thumbnail image on the top right corner of the screen to view the stored image.
5. Tap the **Back** or **Home** button to exit the camera application.



# 2 General Introduction

## OTOFIX BT1

### Smart Touchscreen Battery Analyzer

The OTOFIX BT1 smart touchscreen battery analyzer is a full-featured battery and starting/charging systems diagnostics tool. The OTOFIX BT1 uses a technology called Adaptive Conductance to more accurately determine the health of battery than traditional battery testers. The OTOFIX BT1 can quickly display both voltage and health status of the existing battery, register a new battery, and perform advanced battery and electrical diagnostics. The OTOFIX BT1 is also an advanced diagnostics tool that can identify faults in all systems and display live data relating to those faults. (The all systems diagnostics function is available by subscription.) The easy-to-use Android-based touchscreen tool provides Wi-Fi software updates as well as Wi-Fi printing and sharing of the shop-customized reports which can be printed out with the built-in thermal printer.

There are two main components to the OTOFIX BT1:

- OTOFIX BT1 Tester — the smart touchscreen battery analyzer
- OTOFIX V1 — Vehicle Communication Interface (VCI)

# 2.1 OTOFIX BT1 Battery Tester

## 2.1.1 Function Description

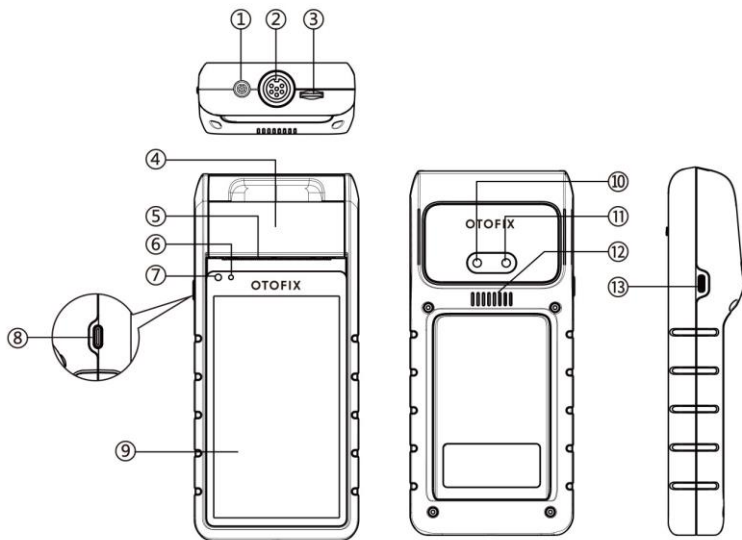

Figure 2-1 OTOFIX BT1 Front/Back/Side View

1. Multimeter Cable Port
2. Battery Clamp Cable Port
3. Micro SD Card Slot
4. Thermal Printer
5. Paper Exit
6. Power LED — refer to Table 2-1 Power LED Description for details
7. Ambient Light Sensor — detects ambient brightness
8. Lock/Power Button — press and hold to turn on and off/restart the tool, or tap to lock the screen
9. 5.5-inch Touchscreen

10. Camera
11. Camera Flash
12. Speaker
13. USB Port

Table 2-1 *Power LED Description*

LED	Color	Description
Power	Green	<ul style="list-style-type: none"> <li>● Lights solid green when the battery is fully charged.</li> <li>● Flashes green while charging, and the tester will automatically powers on.</li> </ul>
	Red	<ul style="list-style-type: none"> <li>● Lights red when the tester is powered on and the battery level is below 15%.</li> <li>● Lights red when illegal operation is detected.</li> </ul>

## 2.1.2 Power Sources

The OTOFIX BT1 tester can receive power from the following sources:

- Internal Battery Pack
- AC/DC Power Supply

---

### **!** IMPORTANT

Do not charge the battery when the temperature is below 0°C (32°F) or above 45°C (113°F).

---

#### **Internal Battery Pack**

The OTOFIX BT1 is powered via its internal rechargeable battery, which can provide sufficient power for about 6 hours of continuous operation if fully charged.

#### **AC/DC Power Supply — using power adapter**

The tester can be powered via an electrical outlet using the AC/DC power adapter. The AC/DC power supply also charges the internal battery pack.

## 2.1.3 Technical Specifications

Item	Description
Operating System	Android 9.0
Screen Display	5.5" LCD touchscreen with 720x1280 resolution
Storage	32 GB
Connectivity	<ul style="list-style-type: none"><li>• Wi-Fi (802.11 a/b/g/n/ac)</li><li>• USB 2.0, Type C</li><li>• BT 5.0 + EDR</li></ul>
Camera	8 Megapixel
Input Voltage	5 V DC
Working Current	< 450 mA at 7.7 V DC
Internal Battery	7.7 V, 3000 mAh
CCA Range	100 to 3000 A
Voltage Range	1.5 V to 36 V
Working Temperature	0°C to 50°C (32°F to 122°F)
Storage Temperature	-10°C to 60°C (14°F to 140°F)
Dimension (L x W x H)	204mm (8.03") x 90mm (3.54") x 32mm (1.25")
Weight	510 g (1.12 lb.)

## 2.2 OTOFIX V1 — Vehicle Communication Interface (VCI)

The OTOFIX V1 is a small vehicle communication interface (VCI) that attaches to a vehicle's diagnostic connector (DLC) and connects wirelessly to OTOFIX tools (including battery test tools and OTOFIX tablets) for vehicle data transmission.

## NOTE

The OTOFIX V1 may or may not be included in your package(s) depending on your order. If this VCI device is not included in your package(s) and you need one, please contact your local distributor or OTOFIX customer service.

### 2.2.1 Function Description

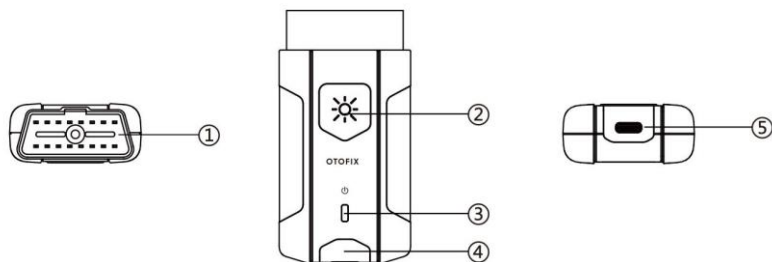

1. Vehicle Data Connector (16-pin)
2. Flashlight Power Button
3. Power LED
4. Vehicle/Connection LED
5. USB Port

#### *VCI LED Description*

LED	Color	Description
Power LED	Yellow	VCI is powered on and performing self-check.
	Green	VCI is ready for use.
	Flashing Red	Firmware is upgrading.

LED	Color	Description
Vehicle / Connection LED	Green	<ul style="list-style-type: none"> <li>● <b>Solid Green:</b> VCI is connected via USB cable.</li> <li>● <b>Flashing Green:</b> VCI is communicating via USB cable.</li> </ul>
	Blue	<ul style="list-style-type: none"> <li>● <b>Solid Blue:</b> VCI is connected via Bluetooth.</li> <li>● <b>Flashing Blue:</b> VCI is communicating via Bluetooth.</li> </ul>

## 2.2.2 Power Sources

The VCI device can receive power from following sources:

- Vehicle Power
- AC/DC Power Supply

### Vehicle Power

The VCI device operates on 12/24 Volt vehicle power, which is powered by the vehicle data connection port. The device powers on whenever it is connected to an OBDII/EOBD-compliant data link connector (DLC).

### AC/DC Power Supply







The VCI device can be powered from a wall socket using the AC/DC power adapter. The flashlight on the VCI device can be powered by this way.

## 2.2.3 Technical Specifications

Item	Description
Communications	<ul style="list-style-type: none"> <li>● BLE + EDR</li> <li>● USB 2.0</li> </ul>
Wireless Frequency	2.4 GHz
Input Voltage Range	6 to 36 V DC

Supply Current	150 mA @ 12 V DC
Operating Temperature	-10°C to 50°C (14 ° F to 122 ° F)
Storage Temperature	-40°C to 80°C (-40 ° F to 176 ° F)
Dimensions (L x W x H)	89.89 mm (3.53") x 46.78 mm (1.84") x 21 mm (0.82")
Weight	70.7 g (0.156 lb.)
Built-in Battery	3.7 V Lithium Battery
Light	White LED

## 2.3 Other Accessories

	<b>Battery Clamp Cable</b> Connects tester to battery
	<b>Power Adapter</b> Together with the USB cable, connects the unit to an external DC power port for power supply.
	<b>USB Cable</b> Together with the power adapter, connects the unit to an external DC power port for power supply.
	<b>Paper Roll (2pcs)</b> Used for thermal printer to print out reports
	<b>Battery Side Post Terminal Type S (2 pcs) (optional)</b> Connects the battery posts and the clamps
	<b>Battery Side Post Terminal Type T (2 pcs) (optional)</b> Connects the battery posts and the clamps

# 3 Getting Started

Ensure the unit is sufficiently charged.

## NOTE

The images and illustrations depicted in this manual may differ from the ones in your tool.

## 3.1 Power Up

Press and hold the **Lock/Power** button on the left side of the tester to switch the unit on. The system will boot up and display the Main Menu.



Figure 3-1 Sample OTOFIX BT1 Tester Main Menu





1. Status Bar
2. Application Buttons
3. Page Indicator

### 3.1.1 Page Indicator and System Status Bar

Descriptions of icons on the status bar and page indicator are displayed below (Table 3-1).



Table 3-1 *System Status Icons and Page Indicator*









Icon	Name	Description
	Page Indicator	Indicates the position of the current page in a list of pages. The user swipes the screen left or right to view the previous or next page.
	Battery Connection	A <b>green check</b> mark at the top right corner indicates the tool is connected to the battery, while a <b>red X</b> icon indicates there is no connection.
	VCI Connection	<b>Green check</b> mark at the top right corner indicates the VCI device is connected, while a <b>red X</b> indicates there is no connection.

### 3.1.2 Application Buttons

Descriptions of the application buttons are displayed below (Table 3-2).

Table 3-2 *Applications*











Button	Name	Description
	In-vehicle Test	Tests batteries that are installed in a vehicle. See In-vehicle Test on page 16.
	Out-vehicle Test	Tests batteries that are not connected to a vehicle. See Out-vehicle Test on page 25.

Button	Name	Description
	Battery Replace	Operation guide for battery replacement. See Battery Replace on page 27.
	Battery Reset	Accesses the Battery Reset function. See Battery Reset on page 29.
	Activate Pro Function	Purchases Diagnostics function. See Activate Pro Function on page 33.
	(subscription only) Diagnostics	Only displays with valid subscription. Reads and/or erases trouble codes. See Diagnostics on page 33.
	Multimeter	Accesses the Multimeter function. (The multimeter is sold separately.) See Multimeter on page 40.
	Update	Accesses system software update menu. See Update on page 46.
	Settings	Accesses the VCI Manager, BAS Manager, System Settings Menu, and more. See Settings on page 48.
	Data Manager	Accesses the saved repair shop, customer, and vehicle data including detailed vehicle diagnostics and test records. See Data Manager on page 49.
	Remote Desktop	Remotely controls the device from any computer or even from another mobile device. Transfers files from the device to a computer, or vice versa. See Remote Desktop on page 52.

### 3.1.3 Drop-down Menu

Swipe down from the top of the screen to access the drop-down menu. Here, users can quickly change some of the most commonly-used settings and functions with a tap. Descriptions of these buttons are displayed below (Table 3-3).

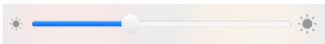
Table 3-3 Drop-down Menu Buttons

Button	Name	Description
	Settings	Quick access to the Settings function.
	Bluetooth	Enables Bluetooth connection.
	Wi-Fi	Enables Wi-Fi connection.
	Flashlight	Turns on/off the flashlight.
	Screenshot	Captures a screenshot of the current screen.
	Auto Brightness	Adjusts the screen brightness automatically.
	Logger	Accesses the Log Collection function.
	Restart	Restarts the application.
 Screen Brightness Slider — Slides to manually adjust the screen brightness.		
 Volume Slider — Slides to manually adjust the volume.		

## 3.2 Power Off

All vehicle communications should be terminated before shutting down the tester. A warning message displays if a shutdown is attempted while the tester is communicating with the vehicle. Forcing a shutdown while the tester is communicating with the vehicle may lead to ECU problems on some vehicles. Please exit the Diagnostics application before shutting down the tester.

➤ **To power off the tester:**

1. Press and hold the **Lock/Power** button.
2. Tap **Power off** option.
3. Tap **OK**.

### Reboot System

In case of system crash, press and hold the **Lock/Power** button and tap **Restart** to reboot the system.

## 3.3 Test Preparation

### 3.3.1 Inspecting the Battery

Before starting a test, inspect the battery for:

- Cracking, buckling or leaking (If you see any of these defects, replace the battery.)
- Corroded, loose or damaged cables and connections (Repair or replace as needed.)
- Corrosion on the battery terminals, and dirt or acid on the case top (Clean the case and terminals using a wire brush and a mixture of water and baking soda.)

### 3.3.2 Connecting to a Battery

1. Connect the clamp cable to the clamp cable port on the tool and tighten the connector of the clamp cable. Press and hold the **Lock/Power** button to turn on the OTOFIX BT1. Select the desired function and follow the on-screen instructions.

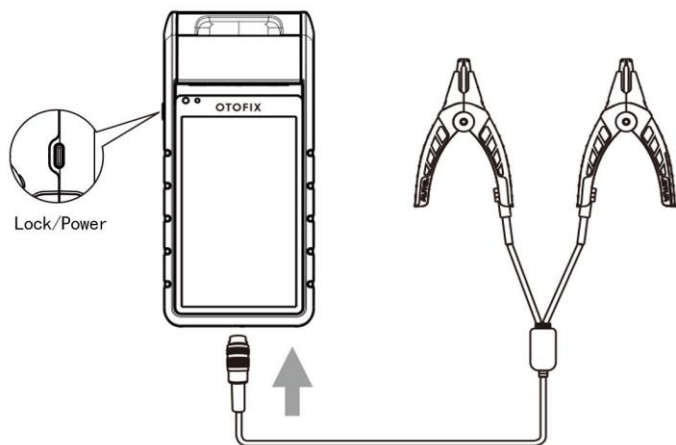

2. Connect the red clamp to the positive (+) terminal and the black clamp to the negative (-) terminal of the battery.

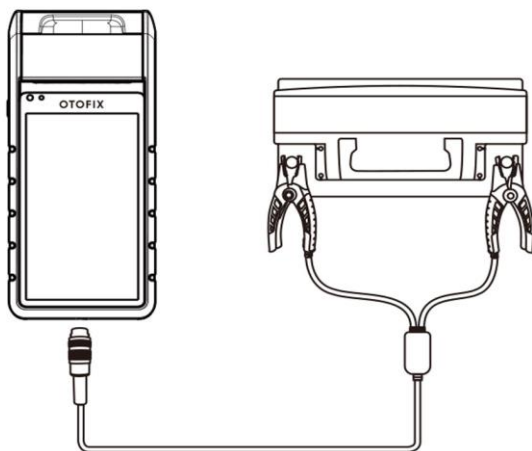

# 4 In-vehicle Test

In-vehicle Test is used for testing batteries that are installed in a vehicle. An in-vehicle test includes battery test, starter test, and generator test. These tests help determine the health status of the battery, the starter, and the generator.

## ! IMPORTANT

A Disclaimer page will appear when accessing any function on the **Home** screen for the first time. Please read the end user agreement and TAP **Accept** to continue. If you tap **Decline**, you will not be able to use the features properly.

## 4.1 Start the Test

Select **In-vehicle Test** on the Home Screen. An illustration displays the OBDII connector location.

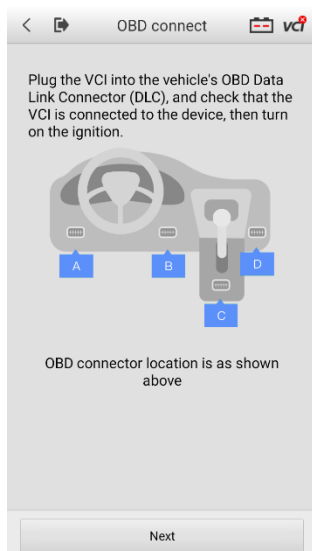





Figure 4-1 Sample In-vehicle Test Home Screen

## Buttons

Table 4-1 Upper Toolbar Buttons

Name	Button	Description
Back		Returns to the previous screen
Home		Returns to the Home Screen
Battery Connection		Displays the battery connection status. The number on the icon indicates the real-time voltage of the tested battery. In the battery test, the button will turn green if the battery is good; otherwise, it will turn red.
VCI Connection		Tap to enter the VCI Manager. The icon also displays the connection status of the VCI.

### 4.1.1 VCI Connection

1. Connect the VCI to the vehicle's OBD Data Link Connector (DLC).
2. Tap the  icon on the top right corner to enter the VCI Manager menu. The device will automatically enable Bluetooth and start searching for available pairing units.
3. The device name will appear on this menu as "Maxi" suffixed with a serial number.
4. Check the serial number on your VCI label and select the desired device for pairing.
5. When paired successfully, the connection status is shown as **Paired** and the vehicle/connection LED will light solid blue.



Figure 4-2 Sample VCI Manager Screen

- Tap the < icon to return to the previous screen. The tab will move to the Vehicle information screen. The VCI button on the top right corner of the screen displays a green check mark, indicating the tester is connected to the VCI.

## 4.1.2 Confirm Vehicle Information

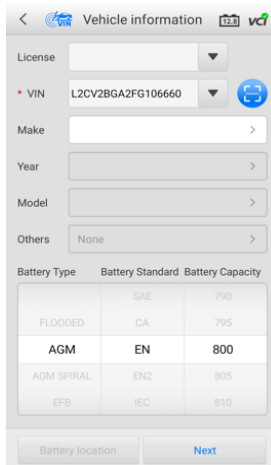



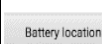

Figure 4-3 Sample Vehicle Information Screen



## Buttons

Name	Button	Description
<b>AutoVIN</b>		After the VCI is connected to the device through the vehicle's OBD Data Link Connector (DLC), turn on the ignition. The vehicle's VIN number will automatically be recognized.
<b>Scan License</b>		Tap to scan license plate.
<b>Scan VIN</b>		Tap to scan Vehicle Identification Number (VIN).
<b>Battery Location</b>		Tap to check the battery location diagram.

### NOTE

The Scan License feature is supported in limited countries and regions. Please manually enter the license numbers if it is not available.

7. The vehicle information will be automatically identified when vehicle communication is established. The Battery Information tab will display from the bottom of the screen.

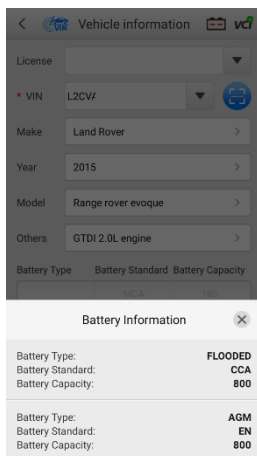

Figure 4-4 Sample Battery Information Screen

8. Tap the **X** icon on the tab to return to the Vehicle information screen. Tap **Battery Location** on the bottom left corner of the screen and review the battery location diagram.
9. Locate the battery, check the battery information on it, and select the correct battery parameters on the screen.
10. Confirm the information on the Vehicle information screen. Tap the corresponding field to manually input the correct parameters if needed. Tap **Next** to continue.

## 4.2 Battery Test

11. The Clamp Connection Diagram will appear. Follow the instructions to connect the clamp cables correctly and tap **Next** to continue.

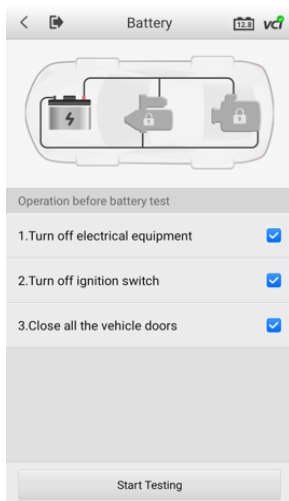

Figure 4-5 *Sample Battery Screen*

12. Follow the on-screen instructions, check the boxes once listed tasks are completed, and tap **Start Testing**.
13. Wait until the test is completed. The test results will be displayed on the tool.

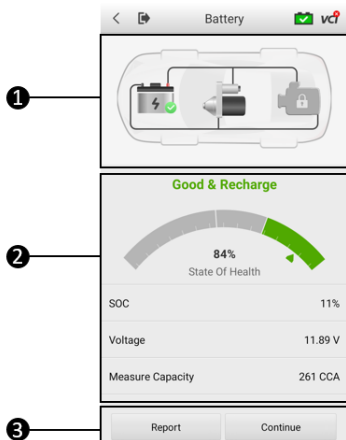

Figure 4-6 Sample Battery Test Result Screen

1. **Process Buttons**
2. **Test Report**
3. **Function Buttons**

### Process Buttons

Tap any of the process buttons to advance to the corresponding test — battery test, starter test or generator test. A status icon will display on the bottom right corner of the button, indicating the test results.

### Battery Test Results

The battery test results include a color-coded result summary, a list of test data, and repair tips.

Table 4-2 Test Results

Result	Repair Tip
Good Battery	Battery is good.
Good & Recharge	Battery is good but insufficiently charged. Recharge the battery.
Charge & Retest	Battery requires charge to determine its condition.
Bad Cell	Replace the battery.
Replace Battery	Replace the battery.

## Function Buttons

The Function Buttons at the bottom of the screen vary depending on the operation. Functions include Report and Replace Battery. The table below provides a brief description of the Function Buttons operations:

Name	Description
<b>Report</b>	Tap to view the test data and results in report form. Tap <b>Print</b> on the bottom of the screen to print the test report to the built-in thermal printer. Tap <b>Email</b> to send the test report to an email address.
<b>Replace Battery</b>	Tap to continue to replace the battery. See Battery Replace on Page 27.
<b>Continue</b>	Tap to perform the next test.

### NOTE

Please always complete the battery test before you proceed to the starter and generator tests.

## 4.3 Starter Test

14. Follow the on-screen instructions to complete the test. Start the engine and let it idle. The test results will display as follows:

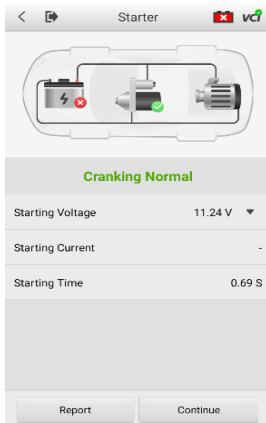

Figure 4-7 Sample Starter Test Result Screen

Table 4-3 Starter Test Results

Result	Description
Cranking Normal	The starter is good
Current Too Low	Low momentary discharge capacity
Voltage Too Low	Low battery storage capacity
Not Started	The starter is not detected for starting

## 4.4 Generator Test

15. Follow the on-screen instructions to complete the test. The test results will display as follows:

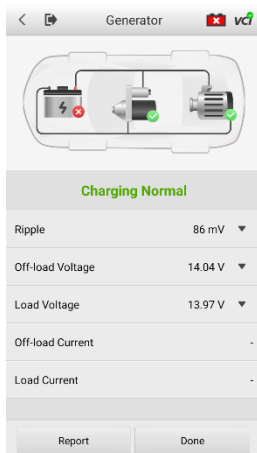

Figure 4-8 Sample Generator Test Result Screen

Table 4-4 Generator Test Results

Result	Description
Charging Normal	The generator is good.
Output Too Low	<ul style="list-style-type: none"> <li>● The belt linking the starter and the generator is loose;</li> <li>● The cable linking the starter and battery is loose or corroded.</li> </ul>
Output Too High	<ul style="list-style-type: none"> <li>● The generator is not properly connected to the ground;</li> <li>● The voltage adjuster is broken and needs replacement.</li> </ul>
Ripple Too Large	The commutation diode is broken.
No Output	<ul style="list-style-type: none"> <li>● The cable is loose;</li> <li>● Some vehicles with power management systems do not provide path for charging due to the sufficient load capacity of the battery;</li> <li>● The generator or the voltage adjuster is broken and needs replacement.</li> </ul>

---

 **NOTE**

To measure the current, connect the current clamp. Tap the **Settings** button on the main menu to enter the application. Swipe the Current Clamp toggle to turn it **ON**.

---

# 5 Out-Vehicle Test

Out-vehicle Test is used to test the condition of batteries that are not connected to a vehicle. This function aims to check the health status of the battery only. The compatible battery types and standards are as follows:

**Types:** FLOODED, AGM, AGM SPIRAL, EFB, and GEL

**Standards:** CCA, SAE, CA, EN, EN2, IEC, DIN, JIS, MCA, BCI, and GB

## 5.1 Test Procedure

1. Connect the tester clamps to the battery terminals.
2. Select the appropriate battery type, rating standard, and CCA value. Tap **Start Testing** to start the test.

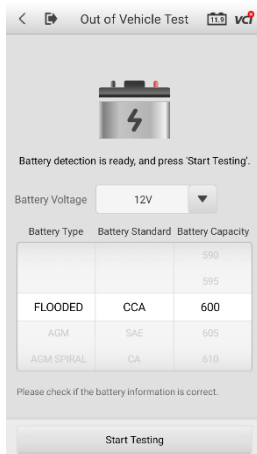

Figure 5-1 Sample Out-vehicle Test Screen

3. The test results will display in a few seconds.

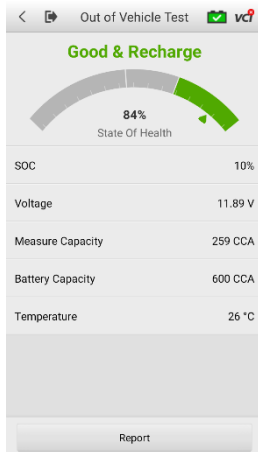

Figure 5-2 Sample Out-vehicle Test Results Screen

## 5.2 Test Results

Icons are color-coded to indicate status.

Result	Description
Good Battery	Battery meets required standards.
Good & Recharge	Battery is good, but low on charge. Fully charge the battery. Check for causes of low charge.
Charge & Retest	Battery requires charge to determine its condition.
Replace Battery	Battery fails to meet industry-accepted standards.
Bad Cell	Battery fails to meet industry-accepted standards.



# 6 Battery Replace

The Battery Replace function guides you to replace the battery step by step. The battery replacement process includes Battery Type Suggestion, Preparation, Battery Replacement steps, New Battery Test and Battery Registration.

➤ **To replace the battery:**

1. Tap the **Help** button at the bottom of each screen to read all the help information carefully before operation, then follow the on-screen instructions to complete the battery replacement.

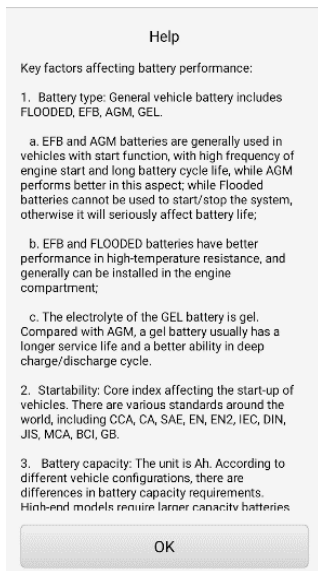

Figure 6-1 Sample Help Screen

2. To save the vehicle's onboard data when the vehicle's battery is removed or disconnected, it is recommended to use a memory saver (optional accessory) to connect a spare battery to the vehicle.

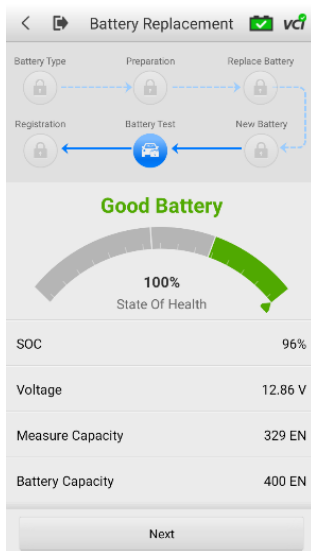

Figure 6-2 Sample New Battery Test Results Screen

- When the new battery test is completed, tap **Next** to automatically proceed to **Auto Registration** in the **Battery Reset** section.

# 7 Battery Reset

The Battery Reset allows users to access the following functions: Auto registration (after battery replacement), BMS reset, Electric appliance reset, Special function and Battery usage history.

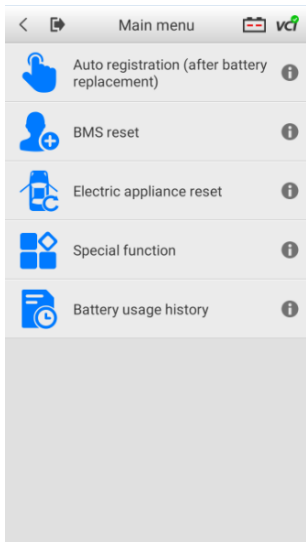

Figure 7-1 Sample Battery Reset Main Menu Screen

## 7.1 Auto Registration (after battery replacement)

Auto registration is often used after the successful installation of a new battery, including BMS reset and Electric appliance reset.

### 7.1.1 BMS Reset

The BMS reset feature enables you to register a new battery after battery replacement. The BMS Reset function varies by vehicle make. Please follow the on-screen instructions to perform the desired functions.

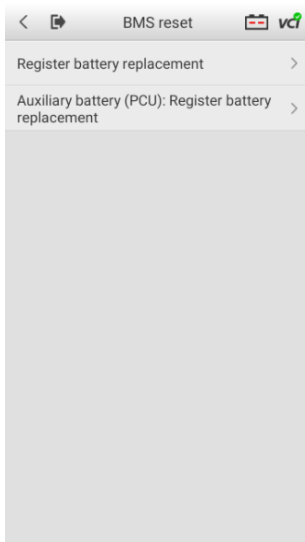

Figure 7-2 *Sample BMS Reset Menu Screen*

After choosing the desired battery replacement registration, information of Scene, Condition, Influence and Note will display. Click **Next** to complete registration.

## 7.1.2 Electric Appliance Reset

When the vehicle power is interrupted in order to replace the battery, and a memory saver has not been used, position settings on some vehicle components will be lost. These settings should be relearned. The functions and related operations in Electric appliance reset vary by vehicle make. Please follow the on-screen instructions to perform the desired functions.

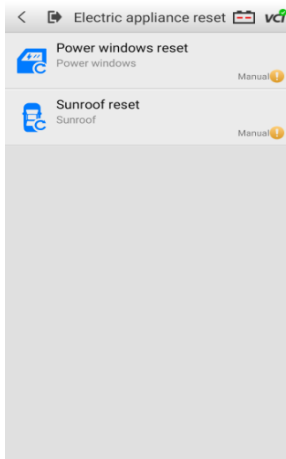

Figure 7-3 Sample Electric Appliance Reset Screen

## 7.2 Special Function

The special function varies by vehicle make. Functions other than battery reset are categorized as special functions. Please follow the on-screen instructions to perform the desired function.

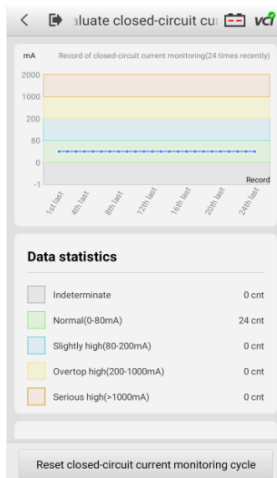

Figure 7-4 Sample Reset Closed-circuit Current Monitoring Cycle Screen (BMW vehicles)

## 7.3 Battery Usage History (only for BMW vehicles)

The Battery usage history function will display the following three tests:

1. **SOC (State of Charge) in the last 5 days:** monitors the SOC status and diagnoses the health status of the battery.
2. **Proportion of SOC duration:** displays battery usage habits of drivers.
3. **Estimated current mileage comparison (battery replacement):** determines the current battery life based on the previous vehicle mileage record.

All three test screens are comprised of three sections:

1. **Main view:** displays data in a waveform or bar graph.
2. **Data description:** provides brief descriptions of the test result.
3. **Suggestion:** offers suggestions on existing problems.

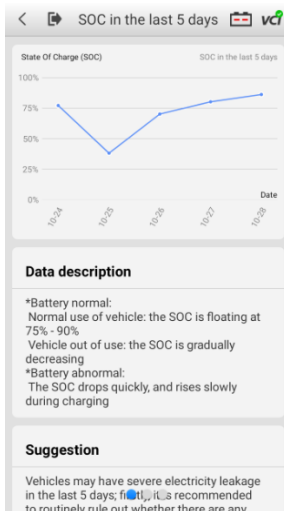

Figure 7-5 Sample SOC in the Last 5 Days Screen

# 8 Diagnostics (subscription only)

## NOTE

The Diagnostics function can only be accessed with a valid subscription.

To subscribe to the Diagnostics function:

1. Go to **Activate Pro Function** on the Home screen.
2. Read **Note of Successful Upgrade** carefully before tapping the **Upgrade** button.
3. Detailed information (including the expenses, order number, item, and expiry date) of your order will display on the screen. Then, select a payment method and tap **Confirm Purchase** to complete your order.



The Diagnostics function enables all systems fault detection, and access to live system data for numerous vehicle control systems, such as engine, transmission, and ABS.



After choosing a diagnostic type (Automatic selection or Manual selection) on the **Diagnostics** main menu, there are two options available when accessing the Diagnosis menu:

1. **Auto Scan** — starts scanning all available systems on the vehicle.
2. **Control Units** — displays a selection menu for all available control units of the vehicle.

After a section is made and the tester establishes communication with the vehicle via the VCI, the corresponding function menu or selection menu will display.

Table 8-1 Top Toolbar Buttons

Button	Description
	Return to the previous page.
	Return to the Home Screen.
	Start and stop data recording.

	Display VCI connection.
	Choose live data parameters by selecting appropriate checkbox. (Available on Live data screen)

## 8.1 Auto Scan

The Auto scan function performs a comprehensive scan of all the ECUs in the vehicle to detect faults and retrieve DTCs.

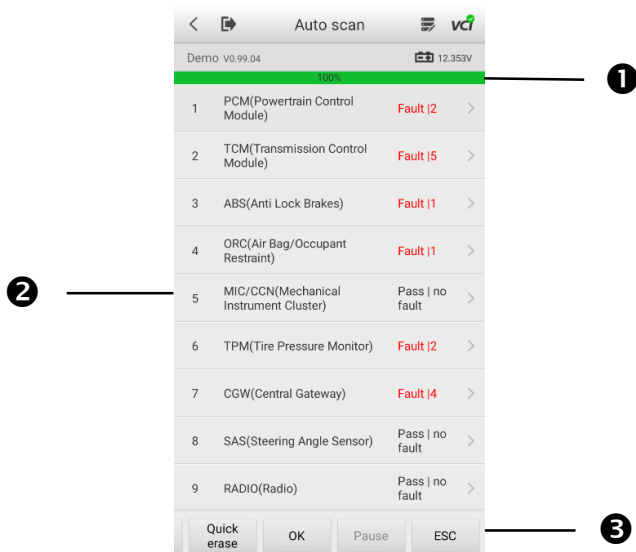

Figure 8-1 Sample Auto Scan Operation Screen

1. Progress Percentage — indicates the test progress
2. Main Section
3. Function Buttons

### Main Section

Column 1 — displays the sequence numbers.

Column 2 — displays the scanned systems.

Column 3 — displays the diagnostic indicators describing test results.



The indicators are defined as follows:

**Fault | #: Fault** indicates detection of fault code(s); **#** indicates the quantity of detected faults.

**Pass | no fault:** indicates the system has completed the scanning process with no fault detected.

Column 4 — to perform further diagnosis or testing on a specific system item, tap the **arrow** button to the right of that item to display the Function menu screen.

## Function Buttons

A brief description of the operations of the Auto Scan Function Buttons are displayed in the table below.

Table 8-2 *Auto Scan Function Buttons*

Name	Description
<b>Save</b>	Saves the scanning results as a PDF document.
<b>Report</b>	Displays the diagnostic data in report form.
<b>Quick Erase</b>	Deletes codes. A warning message will display to alert user of possible data loss when this function is selected.
<b>OK</b>	Confirms the test results. Continues with the system diagnosis after the desired system is selected by tapping the item in the Main Section.
<b>Pause</b>	Suspends scanning. Tap <b>Continue</b> to resume.
<b>ESC</b>	Returns to the previous screen or exits Auto Scan.

## 8.2 Control Units

Select to directly locate a desired control system for testing. Follow the menu-driven procedures and make proper selection; the application guides the user to the proper diagnostic function menu based on these selections.

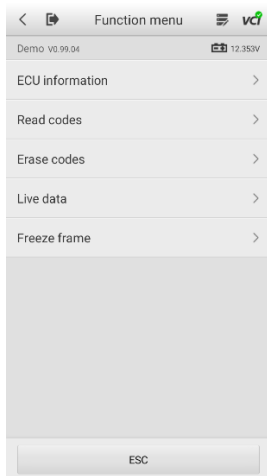

Figure 8-2 Sample Function Menu Screen

The Function menu options may vary by vehicle. The Function menu may include:

- ECU information
- Read codes
- Erase codes
- Live data
- Freeze frame

➤ **To perform a diagnostic function:**

1. Establish communication with the test vehicle.
2. Identify the vehicle by selecting from the menu options.
3. Select the **Diagnostics** section.
4. Locate a system for testing by **Auto Scan** or through menu-driven selections in **Control Units**.
5. Select a diagnostic function from the **Function menu**.

## 8.2.1 ECU Information

This function retrieves and displays the specific information for the tested control unit, including model year, and ECU part number.

The screenshot shows a mobile application interface titled "ECU information". At the top, there is a navigation bar with a back arrow, a home icon, the title "ECU information", and a "vci" logo with a red notification dot. Below the title bar, a status bar displays "Demo v1.00" on the left and "0.0V" on the right. The main content area is a list of vehicle specifications, each in a separate row with a light gray background. At the bottom, there are two buttons: "Save" and "ESC".

Demo v1.00		0.0V
Model year	2016	
ECU part number	68246707AE	
Body style	4-Door hatchback	
Vehicle line	JK	
VIN - original	1C4BJWFG5GL13133 4	
VIN current	1C4BJWFG5GL13133 4	
Software version (Major/Middle/ Minor)	51 04 00	
Hardware version (Major/Minor)	12 47	
Serial number	T00EM2715BN1YJ	
Save      ESC		

Figure 8-3 *Sample ECU Information Screen*

## 8.2.2 Read Codes

This function retrieves and displays the DTCs from the vehicle's control system. The **Read codes** screen varies by each vehicle model being tested. The availability of freeze frame data for viewing varies by vehicle.

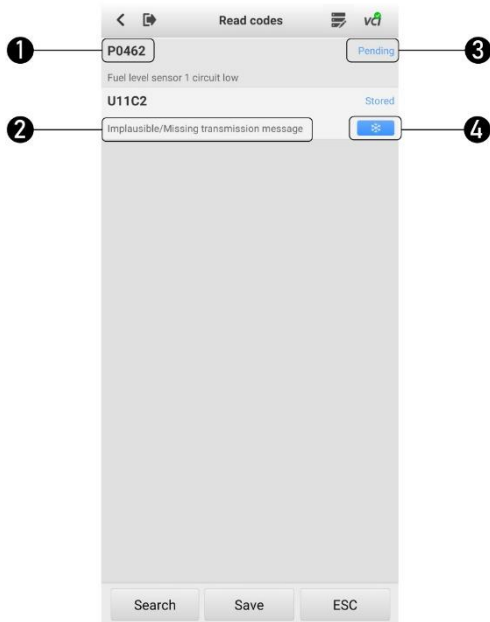

Figure 8-4 *Sample Read Codes Screen*

### Main Section

1. Code section — displays the retrieved codes from the vehicle.
2. Description section — describes the retrieved codes in detail.
3. Status section — indicates the status of the retrieved codes.
4. Snowflake icon — indicates freeze frame data is available for viewing. Selecting this icon will display a data screen, which looks and functions similar to the **Read codes** screen.

## 8.2.3 Erase Codes

After reading the retrieved codes from the vehicle and completing repairs, use this function to erase the codes from the vehicle. Before performing this function, make sure the vehicle's ignition key is in the **ON (RUN)** position with the engine off.

➤ **To erase codes:**

1. Tap **Erase codes** on the Function menu.
2. A message warning that DTCs and/or freeze frame data will be deleted will display:
  - b) Tap **Yes** to continue. A confirmation screen will display when the operation is successful.
  - c) Tap **No** to exit.
3. Tap **ESC** on the confirmation screen to exit **Erase codes**.
4. Return to the Function menu and tap **Read codes** to verify.

# 9 Multimeter

The multimeter (sold separately) is a multi-function, multi-range measuring instrument. Connect the multimeter to the OTOFIX BT1 and access its application directly from the home screen to perform AC/DC voltage, AC/DC current, and resistance measurements, and diode, and connectivity tests. The test results will be displayed in number or graph.

## 9.1 Safety Information

Follow the instructions below to reduce the risk of injury from electric shock and prevent equipment damage.

- Use the multimeter only as specified in this manual.
- Do not apply more than the rated voltage between connectors or between any connector and ground.
- Do not input a value beyond the maximum range when measuring. Remember that the maximum range of this multimeter is 200V.
- To prevent injury or death, do not use the multimeter if it appears to be damaged in any way, and stop use immediately if you are concerned with any abnormal operations.
- To prevent injury or death, never ground yourself when taking electrical measurements. Isolate yourself from ground by using dry rubber insulating mats to cover all exposed/grounded metal. Ensure all clothing including gloves are dry. Stand on rubber mats when using tool.
- Use the test leads or probes supplied with the product, or compatible terminals. Inspect the test leads or probes for damage before use.
- When using probes, keep fingers behind the finger guards on the probes.
- Use the supplied replacement fuses or specified replacement parts.
- Always consider electrical and electronic equipment to be energized (live). Never assume any equipment is de-energized.
- When making electrical connections, connect the common test lead before connecting the live test lead; when disconnecting, disconnect the live test lead before disconnecting the common test lead.
- When measuring current, turn off circuit power before connecting the multimeter to the circuit. Remember to place the multimeter in series with

the circuit.

- After current measurement is finished, turn off the power to the circuit before removing the test leads and before reconnecting any disconnected wires or devices.
- Do not add voltage to the input terminal when measuring resistance.
- To avoid electric shock, turn off the power to the component before connecting.
- To prevent damage, always use and store your multimeter in appropriate environments.
- Do not use in wet or damp conditions, or around explosive gas or vapor.
- Do not tamper with or disassemble the multimeter, connectors or accessories. Internal damage will affect performance.
- Before carrying out maintenance and cleaning of the multimeter, make sure the unit is NOT connected to a power source, vehicle or computer.
- When cleaning the multimeter, use a damp, soft cloth with mild detergent. Do not allow water to enter the multimeter casing.

## 9.2 Getting Started

Before opening the **Multimeter** application, ensure the multimeter device is connected to the tester via the multimeter cable (see diagram below). Tap **no more** to hide diagram.

The device will beep when successfully connected with the tester.

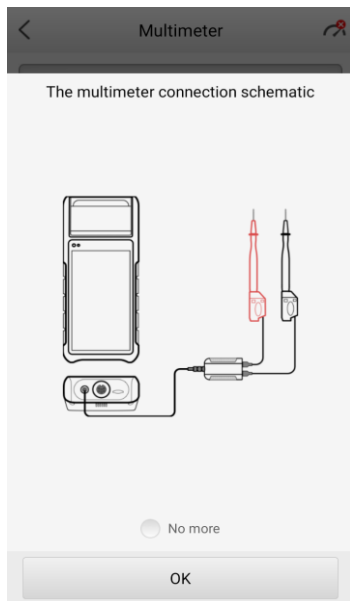

Figure 9-1 *Sample Multimeter Connection Schematic*

## 9.3 Screen Layout and Operation

Tap the **Multimeter** icon on the main menu to view the multimeter page.



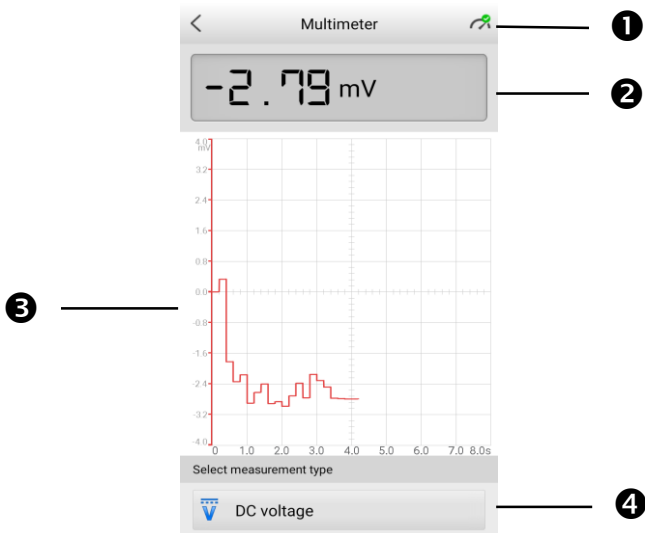

Figure 9-2 *Sample Multimeter Test Screen*

1. Multimeter icon
2. Digital display
3. Main view section
4. Measurement type selection

### 9.3.1 Multimeter Icon

The Multimeter status icon indicates the connection status with the tester. A green check mark means that the tester and the multimeter are connected; a red "X" means that the device and the tester are not connected.

### 9.3.2 Digital Display

This section displays the digital measurement results.







### 9.3.3 Main View Section

The main view section features a coordinate grid with the X-axis representing the time duration and the Y-axis representing the amplitude level.

### 9.3.4 Measurement Type Selection

This multimeter can be used to measure AC voltage, DC voltage, resistance, AC electricity, DC electricity, diode, and connectivity.

The measurement types include:

Icon	Name	Description
	AC voltage	Measures the voltage in the electrical circuit.
	DC voltage	
	Resistance	Measures the resistance of the electrical circuit or the component.
	AC current	Measures current amperage by using the optional current clamp.
	DC current	
	Diode	Conducts a diode test of the electrical circuit.
	Connectivity	Determines whether a low impedance exists two points in the electrical circuit. If the impedance is less than 100 ohms, the circuit is “closed”, otherwise, the circuit is “open”.

#### NOTE

1. AC/DC current is measured with clamps, while AC/DC voltage, diode and connectivity are measured with probes.
2. When selecting the **Resistance** measurement type, the self-calibration mark  will display after **Resistance**, indicating the multimeter will return to zero in order to improve accuracy.
3. When measuring AC/DC current, different measuring ranges require different operations of the clamp (see Figure 9-3). Tap **no more** to hide diagram.

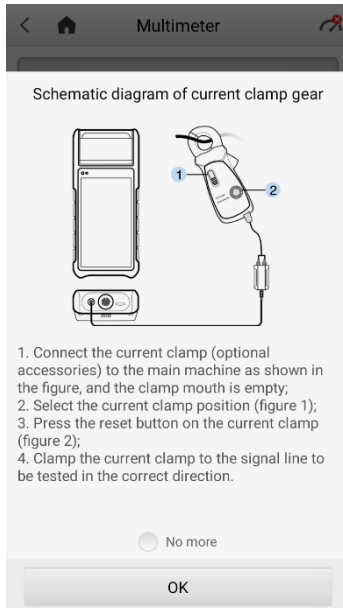

Figure 9-3 Sample Schematic Diagram of Current Clamp

# 10 Update

This function allows you to update your OTOFIX BT1 software through Wi-Fi connection, including software for operating system, applications, battery testing, battery registration, and vehicle manufacturers. A notification displays when updates are available. Ensure the tool is connected to a stable Wi-Fi network and follow the on-screen instructions to update software.

Tap into any available vehicle software to view vehicle model coverage. Updates for previously-installed software may display information regarding improved diagnostics and service functions.

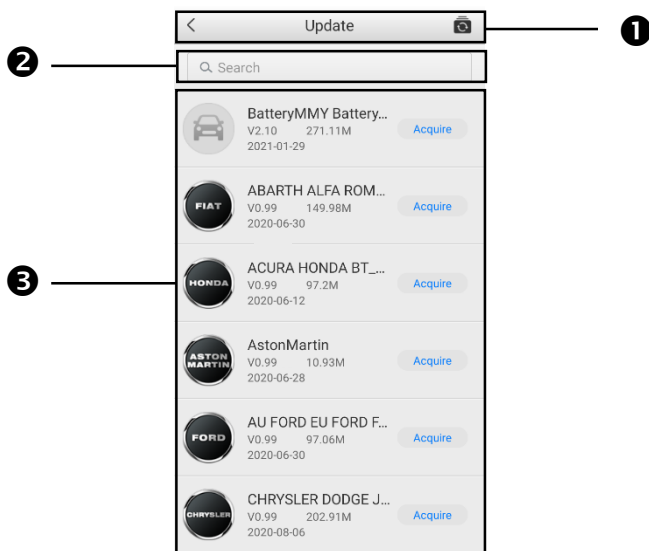



Figure 10-1 *Sample Update Main Screen*

1. Upper Toolbar
2. Search Bar
3. Main Section

## Upper Toolbar

Button	Description
	Returns to the previous page.
	Tap to acquire all software.

## Search Bar

Searches for updates by vehicle manufacturer.

## Main Section

- Left Column — displays vehicle logos.
- Middle Column — displays the newest software version for update and information of the size and release date of the update package.
- Right Column — buttons vary by the operation.
  - a) Tap **Acquire** to download and install the desired software.
  - b) Tap the button to suspend the updating procedure.
  - c) Tap **Paused** to continue updating.

# 11 Settings

Access the **Settings** menu to adjust default settings and view information about the OTOFIX BT1 system.

Option	Description
<b>VCI manager</b>	VCI Manager is for connecting the OTOFIX BT1 with a VCI device via Bluetooth. This option allows you to pair the tester with the VCI device, check the communication status, and upgrade the VCI firmware.
<b>BAS manager</b>	Allows you to check and update the firmware version and resources.
<b>System settings</b>	Sets and adjusts the Wi-Fi connection, language, date and time, display and sound, sleep mode, cache clearing, and factory reset.
<b>About</b>	Displays information about the OTOFIX BT1, including device serial number, password, system version, hardware version, APP version, BAS version, BAS firmware version, VCI firmware, VCI software, and capacity.
<b>Unit</b>	Selects the units of measure system. Choose between Metric and Imperial units.
<b>Current clamp</b>	Swipe the <b>Current clamp</b> toggle to enable current measurement.

# 12 Data Manager

The Data Manager application allows you to store, print, and review the saved files, manage workshop information and customer information records, and keep test vehicle history records. There are six main functions available.

## 12.1 Test Records

This option stores records of test vehicle history, including battery tests and diagnostics. The diagnostics records also provide direct access to the previously-tested vehicle and allow you to directly restart a diagnostic session without the need to perform vehicle selection.

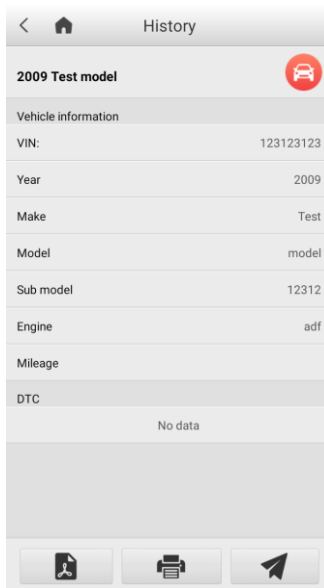



Figure 12-1 *Sample Diagnostics Test Records Screen*

## 12.2 Workshop Information

The Workshop Information form allows you to input, edit, and save detailed workshop information, such as shop name, address, phone number, and other remarks, which, when printing vehicle diagnostics reports and other associated test files, will display as the header of the printed reports.

## 12.3 Image

The Image option is a JPG database containing all captured screenshots. Tap the  icon on the top right corner of the screen to delete the selected images.

## 12.4 PDF

The PDF option stores and displays all PDF files of saved data. After entering the PDF database, select a PDF file to view the stored information. Tap the “...” multi-function icon on the top right corner of the screen to share the files or print them out on your PC.

## 12.5 Uninstall Apps

This option allows you to manage the firmware applications installed on the Diagnostics System. Selecting this option opens a management screen, on which you can check all available vehicle diagnostic applications.

Select the vehicle firmware you want to delete, tap the **Delete** button on the bottom of the screen to delete the firmware from the system database.

## 12.6 Data Logging

The Data Logging option allows you to launch the Support platform to view all records on the diagnostic system. The Data Logging option keeps records of all **Feedback** (submitted), **Not Feedback** (not submitted but saved) or **History** (up to the latest 20 test records) data loggings on the diagnostic system. You can edit and send test records by using the **Data logging** function. OTOFIX support personnel will receive and process submitted reports through the Support platform.



---

 **NOTE**

**Thermal Paper**

The internal printer is shipped with two rolls of thermal paper (2.3" wide by 0.98" in diameter). Replacement rolls are available in most stationery stores.

➤ **To replace the paper roll:**

1. Open the cover of the printer by gently lifting it upwards.
  2. Remove the spent roll if any.
  3. Insert a new paper roll.
  4. Pull the paper out past the cutter at the front of the printer. While doing so, make sure that the paper roll stays taut and doesn't unroll.
  5. Push the cover down to snap it closed. For a clean tear, pull the paper along the serrated edge.
-

# 13 Remote Desktop

The Remote Desktop application launches the TeamViewer Quick Support program, which is a simple, fast, and secure remote-control interface. You can use the application to receive remote support from OTOFIX support center, colleagues or friends by allowing them to control your OTOFIX BT1 tester on their PC via the TeamViewer software.

If you think of a TeamViewer connection as a phone call, the TeamViewer ID would be the phone number under which all TeamViewer Clients can be reached separately. Computers and mobile devices that run TeamViewer are identified by a unique global ID. The first time the Remote Desktop application is launched, this ID is generated automatically based on the hardware characteristics of the tester. The user cannot change the ID.

Make sure the tester is connected to the Internet before launching the Remote Desktop application, so that the OTOFIX BT1 is able to receive remote support from the third party.

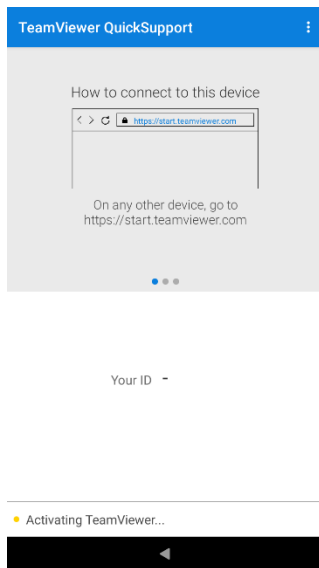

Figure 13-1 Sample TeamViewer Interface Screen

➤ **To receive remote support from a partner:**

1. Power on the OTOFIX BT1.
2. Tap the **Remote Desktop** application from the Main Menu. The TeamViewer interface appears and the device ID is generated and shown.
3. Your partner must install the Remote Control software to his/her computer by downloading the TeamViewer program (full version) online (<http://www.teamviewer.com>). Start the software on his/her computer at the same time in order to provide support and take control of the OTOFIX BT1 remotely.
4. Provide your ID to the partner and have them to send you a remote control request.
5. A prompt will appear asking you to allow remote control on your device.
6. Tap **Allow** to accept or **Deny** to reject.

Refer to the associated TeamViewer documents for additional information.

# 14 Register Tool

To update the software on your tool, the tool must be registered. The installation of the latest firmware and vehicle software is vital to the successful operation of the BT1. Register the tool and download the software prior to using. Register directly on the tool or via Internet on a mobile device or computer.

## 14.1 Registration via Tester

1. First, make sure the device is connected to Wi-Fi.
2. The device will automatically detect whether the user has registered; if not, a dialog box will display asking the user to register the tool.
3. Tap **OK** to view the sign-in screen.
4. Create an Autel ID using a readily accessible email address.
5. Enter your email address and password, and tap **Verification code**. Check your email for the verification code. Enter the code and tap **Sign up**.
6. The serial number and password fields will be filled automatically. Tap **REGISTER**.

## 14.2 Registration via an Internet Browser on a Computer or Mobile Device

1. Visit <http://pro.otofixtech.com/>.
2. If you already have an Autel account, sign In with your account ID and password; if you are a new member to Autel, click on the **Create Autel ID** button on the screen to create an ID.
3. The online system will send a verification code to the registered email address. Input the code in the **Verification code** field and complete the other required fields. Read through Autel's **Terms and Conditions** and click on **Agree**. Click **Create Autel ID** to continue. A product registration screen will display.
4. Check the device's serial number and password from the **Settings > About** screen.
5. Select your product model, enter the product serial number and password on the **Product Registration** screen, and click **Submit** to complete the registration procedure.

# 15 Maintenance and Service

To ensure that the tester and the combined VCI unit perform at their optimum level, we advise that the product maintenance instructions covered in this section are read and followed.

## 15.1 Maintenance Instructions

The following shows how to maintain your devices, together with precautions to take.

- Use a soft cloth and alcohol or a mild window cleaner to clean the touch screen of the tester.
- Do not use any abrasive cleansers, detergent, or automotive chemicals on the tester.
- Maintain the devices in dry conditions and keep them within normal operating temperatures.
- Dry your hands before using the tester. The touchscreen of the tester may not work if the touch screen is moist, or if you tap the touch screen with wet hands.
- Do not store the devices in humid, dusty or dirty areas.
- Check the housing, wiring, and connectors for dirt and damage before and after each use.
- At the end of each work day, wipe the device housing, wiring, and connectors clean with a damp cloth.
- Do not attempt to disassemble the tester or the VCI unit.
- Do not drop or cause severe impact to the devices.
- Use only authorized battery chargers and accessories. Any malfunction or damage caused by the use of unauthorized battery charger and accessories will void the limited product warranty.
- Ensure that the battery charger does not come in contact with conductive objects.
- Do not use the tester beside microwave ovens, cordless phones and some medical or scientific instruments to prevent signal interference.

## 15.2 Troubleshooting Checklist

### A. When the tester does not work properly:

- Make sure the tester has been registered online.
- Make sure the system software and diagnostic application software are properly updated.
- Make sure the tester is connected to the Internet.
- Check all cables, connections, and indicators to ensure the signal is being received.

### B. When battery life is shorter than usual:

- This may happen when you are in an area with low signal strength. Turn off your device if not in use.

### C. When you cannot turn on the tester:

- Make sure the tester is connected to a power source or the battery is charged.

### D. When you are unable to charge the tester:

- Your charger maybe out of order. Contact your local distributor for assistance.
- You may be attempting to use the device in an overly hot/cold temperature. Charge the device in a cooler or warmer area.
- Your device may have not been connected to the charger properly. Check the connector.

---

#### NOTE

If the problems persist, please contact OTOFIX technical support personnel or your local distributor.

---

## 15.3 About Battery Usage

Your tester is powered by a built-in Lithium-ion Polymer battery. This means that, unlike other forms of battery technology, you can recharge your battery while some charge remains without reducing your tester's autonomy due to the "battery memory effect" inherent in those technologies.

---

 **DANGER**

1. The built-in Lithium-ion Polymer battery is factory replaceable only; incorrect replacement or tampering with the battery pack may cause an explosion.
  2. Do not use a damaged battery charger.
- 
- Do not disassemble or open, crush, bend or deform, puncture or shred.
  - Do not modify or remanufacture, attempt to insert foreign objects into the battery, expose to fire, explosion or other hazards.
  - Make sure to use the charger and USB cables that come together in the package only. If you use the other charger and USB cables, you might incur malfunction or failure of the device.
  - Only use the charging device that has been qualified with device per the standard. Use of an unqualified battery or charger may present a risk of fire, explosion, leakage, or other hazards.
  - Avoid dropping the tester. If the tester is dropped, especially on a hard surface, and the user suspects damage, contact support.
  - The battery recharging time varies depending on the remaining battery capacity.
  - Battery life inevitably shortens over time.
  - Since over charging may shorten battery life, remove the tester from its charger once it is fully charged. Unplug the charger once charging is complete.
  - Leaving the tester in hot or cold places, especially inside a car in summer or winter, may reduce the capacity and life of the battery. Always keep the battery within normal temperatures.

## 15.4 Service Procedures

This section introduces information for technical support, repair service, and application for replacement or optional parts.

### 15.4.1 Technical Support

If you have any question or problem on the operation of the product, please contact us.

OTOFIX NORTH AMERICA

- **Email:** [ussupport@otofixtech.com](mailto:ussupport@otofixtech.com)

- **Web:** [www.otofixtech.com](http://www.otofixtech.com)
- **Phone:** (833) 686-1349 (OTO-1FIX) (Monday-Friday 9am-6pm EST)
- **Address:** 175 Central Avenue, Suite 200, Farmingdale, New York, USA 11735

#### OTOFIX CHINA HQ

- **Email:** [support@otofixtech.com](mailto:support@otofixtech.com)
- **Website:** [www.otofix.cn](http://www.otofix.cn)
- **Phone:** 0086-755-2267-2493 (Monday-Friday, 9:00AM-6:00PM Beijing Time)
- **Address:** 7th, 8th and 10th floor, Building B1, Zhiyuan, Xueyuan Road, Xili, Nanshan, Shenzhen, 518055, China

For technical assistance in other markets, please contact your local distributor.

## 15.4.2 Repair Service

If it becomes necessary to return your device for repair, please download the repair service form from [www.otofixtech.com](http://www.otofixtech.com), and fill in the form. The following information must be included:

- Contact name
- Return address
- Telephone number
- Product name
- Complete description of the problem
- Proof-of-purchase for warranty repairs
- Preferred method of payment for non-warranty repairs

---

#### **NOTE**

For non-warranty repairs, payment can be made with Visa, Master Card, or with approved credit terms.

---

Send the device to your local distributor, or to the below address:

7th, 8th and 10th Floor, Building B1, Zhiyuan, Xueyuan Road, Xili, Nanshan, Shenzhen, 518055, China



# 16 Compliance Information

FCC Compliance

FCC ID: WQ8BATSTB2022

WQ8BATSTBV200

This device complies with part 15 of the FCC Rules. Operation is subject to the following two conditions:

- a) This device may not cause harmful interference, and
  - b) This device must accept any interference received, including interference that may cause undesired operation.
- 

## WARNING

Changes or modifications not expressly approved by the party responsible for compliance could void the user's authority to operate the equipment.

---

## NOTE

This equipment has been tested and found to comply with the limits for a Class B digital device, pursuant to Part 15 of the FCC Rules. These limits are designed to provide reasonable protection against harmful interference in a residential installation.

---

This equipment generates uses and can radiate radio frequency energy and, if not installed and used in accordance with the instructions, may cause harmful interference to radio communications. However, there is no guarantee that interference will not occur in a particular installation. If this equipment does cause harmful interference to radio or television reception, which can be determined by turning the equipment off and on, the user is encouraged to try to correct the interference by one or more of the following measures:

- Reorient or relocate the receiving antenna.
- Increase the separation between the equipment and receiver.
- Connect the equipment into an outlet on a circuit different from that to which the receiver is connected.
- Consult the dealer or an experienced radio/TV technician for help.

## **SAR**

The radiated output power of this device is below the FCC radio frequency exposure limits. Nevertheless, the device should be used in such a manner that the potential for human contact is minimized during normal operation.

The exposure standard for wireless devices employs a unit of measurement known as the Specific Absorption Rate, or SAR. The SAR limit set by the FCC is 1.6 W/Kg. Tests for SAR are conducted using standard operating positions accepted by the FCC with the device transmitting at its highest certified power level in all tested frequency bands.

Although the SAR is determined at the highest certified power level, the actual SAR level of the device while operating can be well below the maximum value. This is because the device is designed to operate at multiple power levels so as to use only the power required to reach the network. To avoid the possibility of exceeding the FCC radio frequency exposure limits, human proximity to antenna should be minimized.

## **FCC Radiation Exposure Statement**

This equipment complies with FCC radiation exposure limits set forth for an uncontrolled environment. This equipment should be installed and operated with minimum distance 20cm between the radiator & your body.

## **CE COMPLIANCE**

This product is declared to conform to the essential requirements of the following Directives and carries the CE mark accordingly:

EMC ETSI EN 301 489-1 V2.2.3 (2019-11)

ETSI EN 301 489-17 V3.1.1 (2017-02)

EN 55032: 2015

EN 55035: 2017

Safety EN 62368-1: 2014+A11: 2017

Health EN 50566: 2017

EN 62479: 2010

EN 62209-2: 2010

Radio ETSI EN 300 328 V2.2.2 (2019-07)

ETSI EN 300 440 V2.2.1 (2018-07)

ETSI EN 301 893 V2.1.1 (2017-05)



# 17 Warranty

## 17.1 Limited One Year Warranty

Autel Intelligent Technology Corp., Ltd. (the Company) warrants to the original retail purchaser of this OTOFIX BT1 that should this product or any part thereof during normal usage and under normal conditions be proven defective in material or workmanship and results in product failure within 1 year period from the date of purchase, such defect(s) will be repaired, or replaced (with new or rebuilt parts) with Proof of Purchase, at the Company's option, without charge for parts or labor directly related to the defect(s).

The Company shall not be liable for any incidental or consequential damages arising from the use, misuse, or mounting of the device. Some states do not allow limitation on how long an implied warranty lasts, so the above limitations may not apply to you.

### **This warranty does not apply to:**

- 1) Products subjected to abnormal use or conditions, accident, mishandling, neglect, unauthorized alteration, misuse, improper installation or repair or improper storage;
- 2) Products whose mechanical serial number or electronic serial number has been removed, altered or defaced;
- 3) Damage from exposure to excessive temperatures or extreme environmental conditions;
- 4) Damage resulting from connection to, or use of any accessory or other product not approved or authorized by the Company;
- 5) Defects in appearance, cosmetic, decorative or structural items such as framing and non-operative parts.
- 6) Products damaged from external causes such as fire, dirt, sand, battery leakage, blown fuse, theft or improper usage of any electrical source.

---

**!** **IMPORTANT**

All contents of the product may be deleted during the process of repair. You should create a back-up copy of any contents of your product before delivering the product for warranty service.

---